

## Economy Delineator Bases

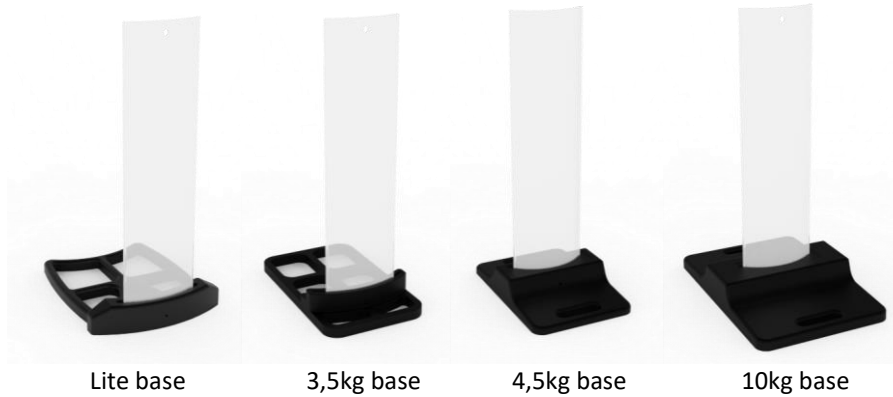

### Features:

Made from various recycled materials • Stack and pack easily and suit standard pallets • All bases suit all econo blade types • Lock pins available on request • 4,5 and 10kg bases are self-supporting and do not require sandbags for ballast • Highly UV and temperature resistant • Available in yellow and black options

SKU	Description	mm mm (A)	mm (B)	mm (C)	KG
DL-01-B	Lite Base	80	390	482	0,76
DL-02-B	3,5kg Base	82	300	500	3,5
DL-03-B	4,5kg Base	88	300	455	4,5
DL-04-B	10kg Base	95	390	590	10

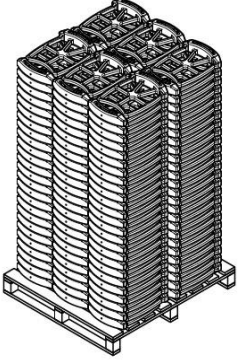
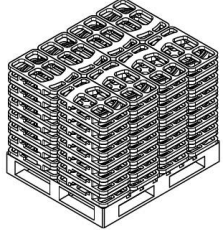
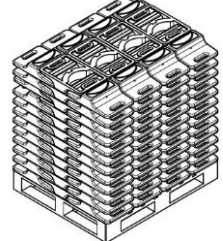
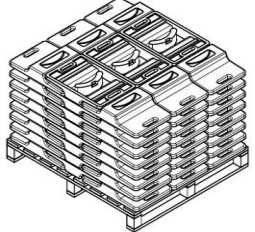

**XX = Colour Option:** Colours available include Black (Bl), yellow (Y).

**Palletisations**

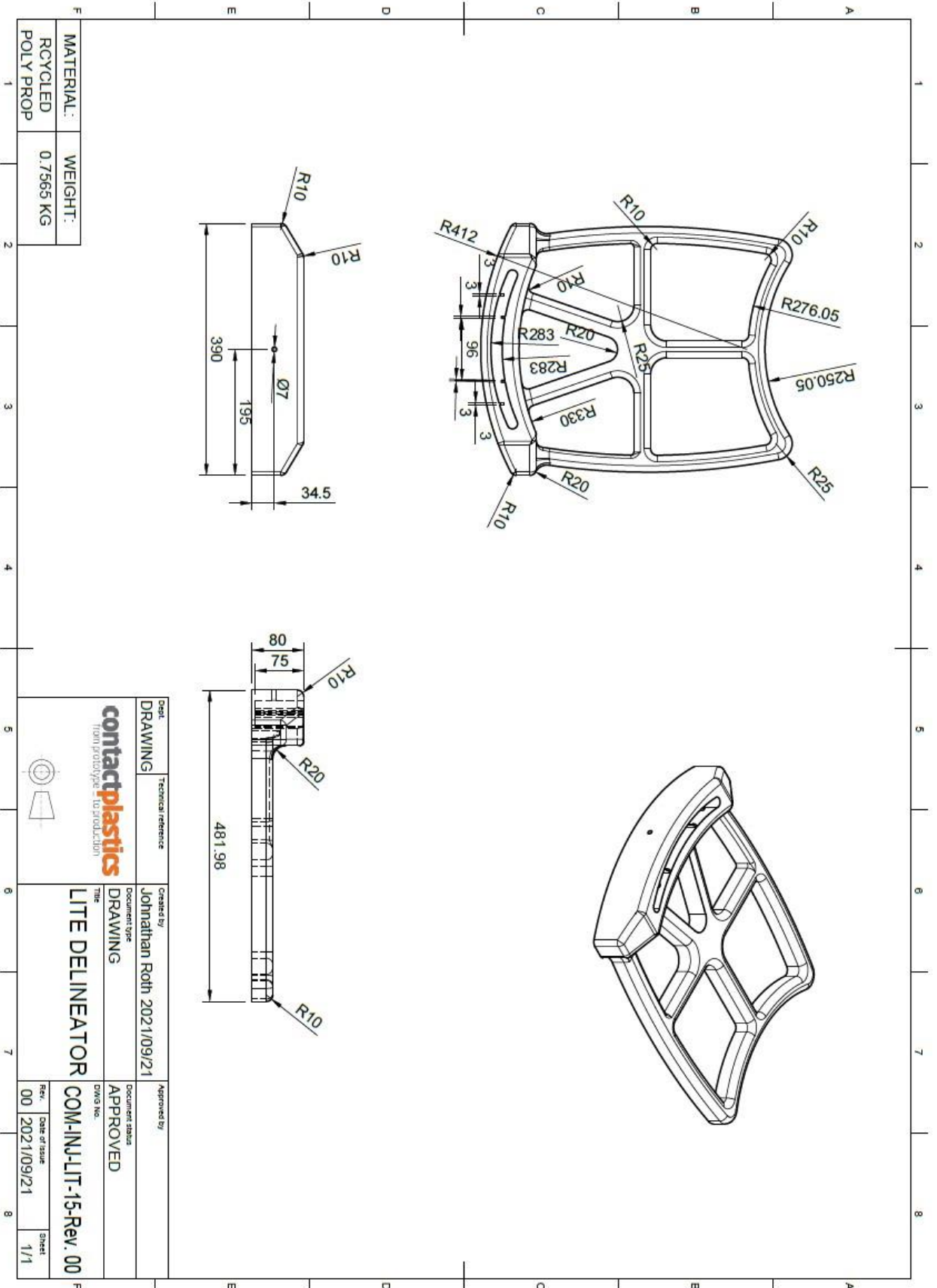
Type	Length	Width	Height	Mass [kg]	Parts/Pallet	Diagram
Lite	1340	1200	2202	101,97	300 units	
3,5kg	1000	1200	954	398,24	112 units	
4,5kg	1028,5	1200	1226	746	144 units	
10kg	1340	1200	930	720	72 units	



MATERIAL:	WEIGHT:
RCYCLED POLY PROP	0.7565 KG

Doc. No.	Technical reference	Created by	Approved by
DRAWING		Johnathan Roth 2021/09/21	
		Document type	Document status
		DRAWING	APPROVED
<b>Lite Delineator</b>		DWG No.	COM-INJ-LIT-15-Rev. 00
Rev.	Date of issue	Sheet	
00	2021/09/21	1/1	

